

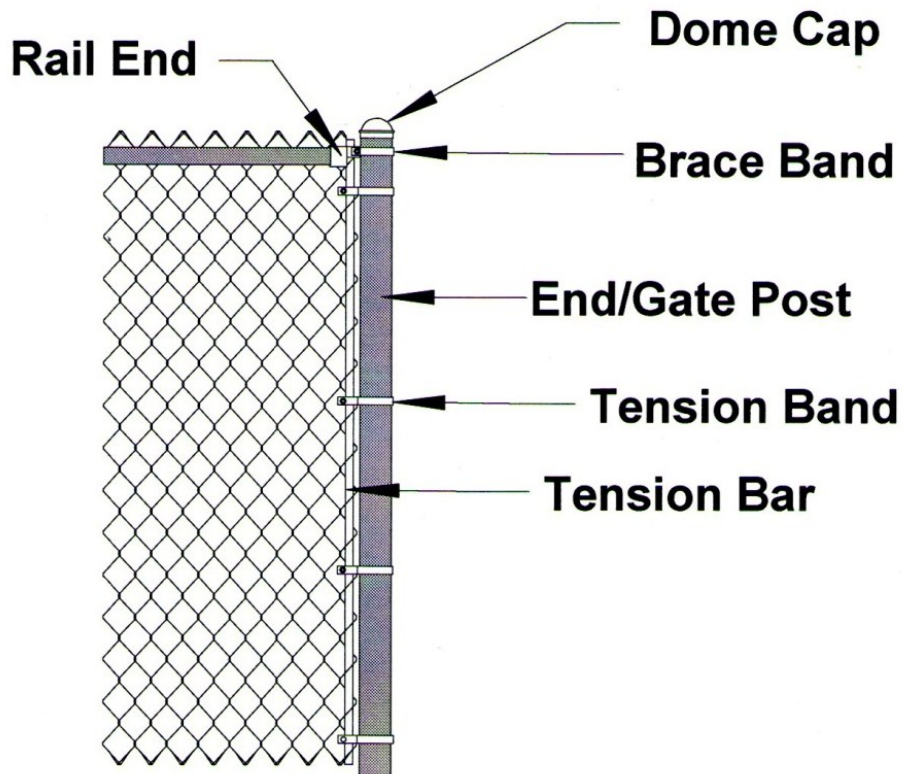

End or Gate Post Detail

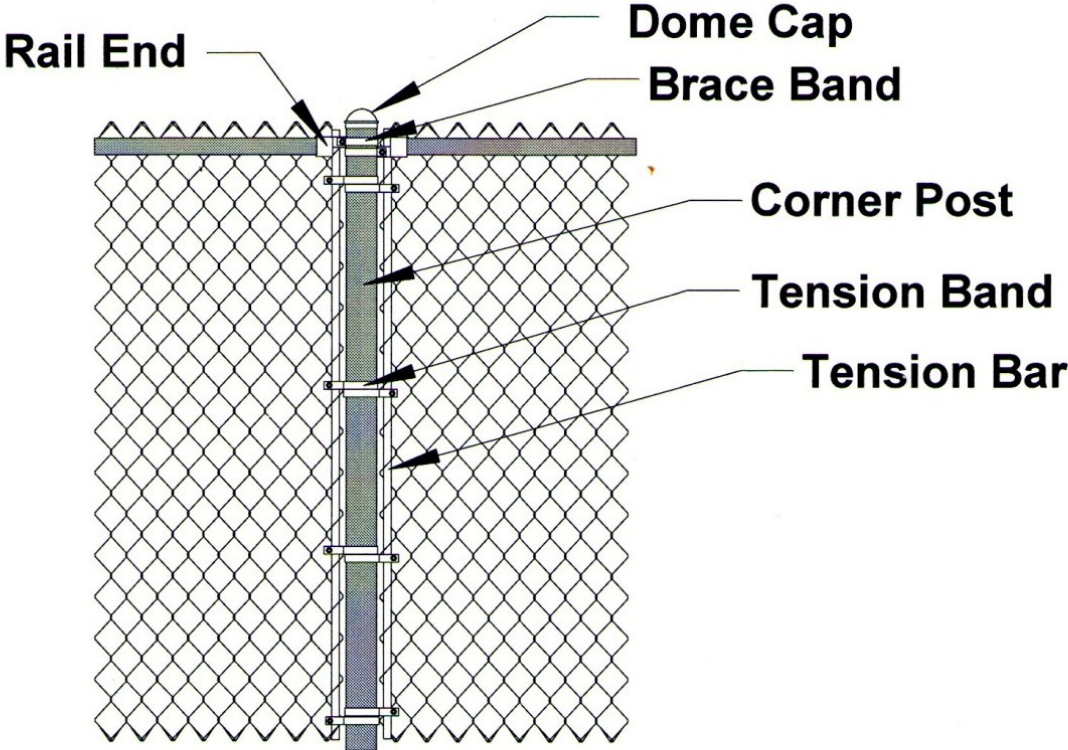

Corner Post Detail



Typical Rail Joints

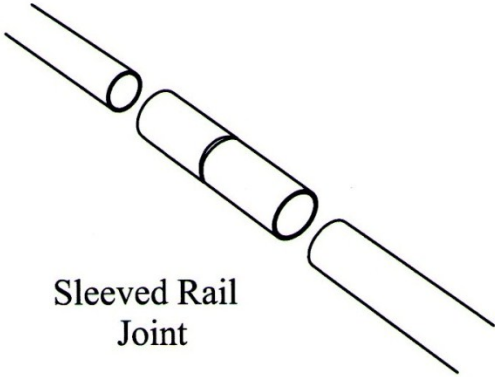
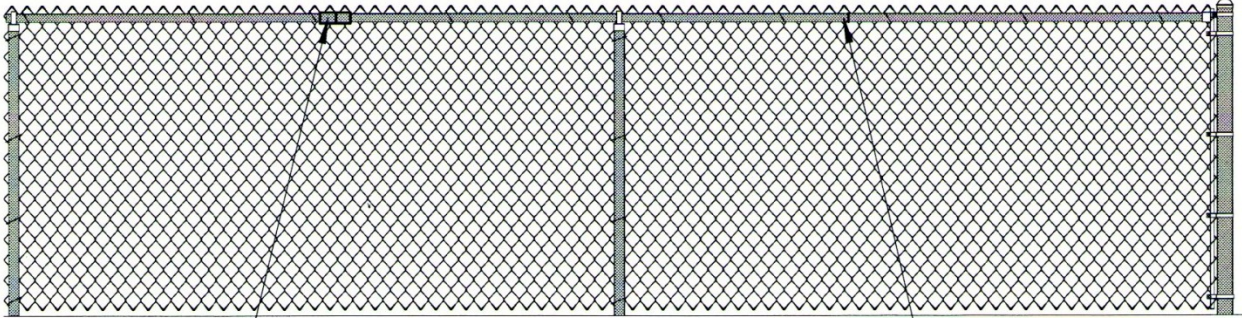

Sleeved Rail
Joint

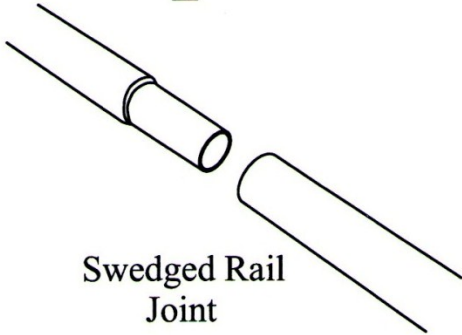

Swedged Rail
Joint

Chainlink Fence Detail

4' - 6' Chain Link with toprail

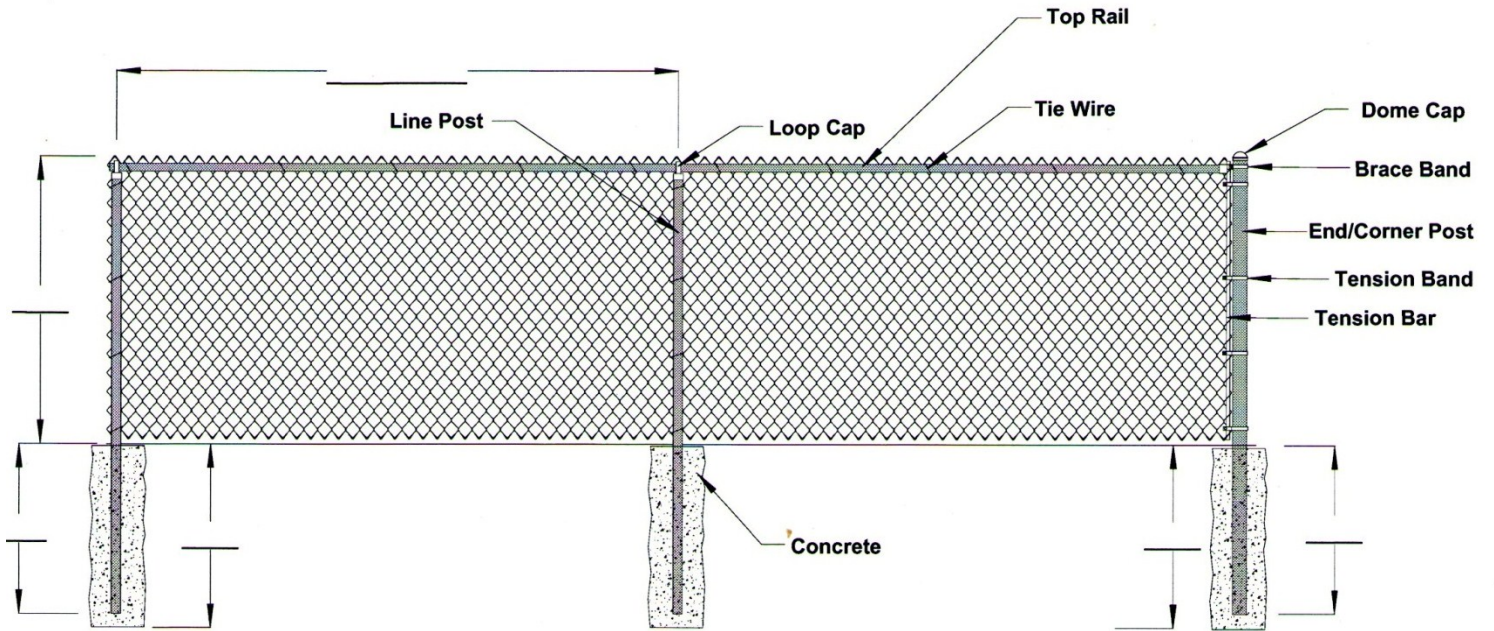

Typical Fittings Details



Barb Arm

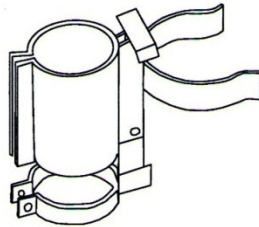

Industrial Locking Latch

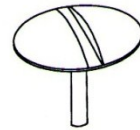

Gate Center Stop



"V" Arm or
"Double Barb Arm"

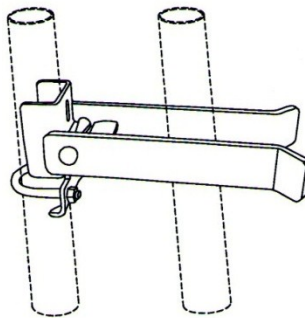

Heavy Industrial
Double Gate Latch

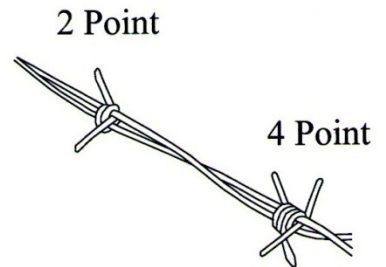

Barbed Wire

Typical Fittings Details

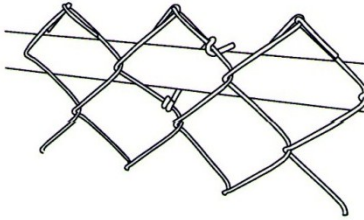

Tie Wire Detail

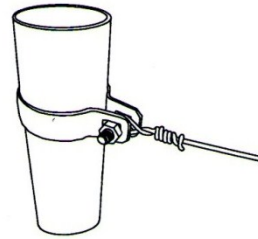

Tension Wire Detail

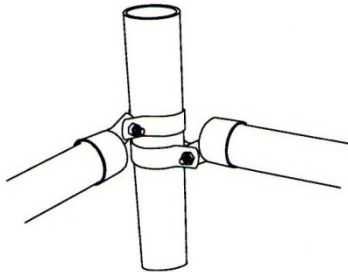

Rail & Rail End Detail

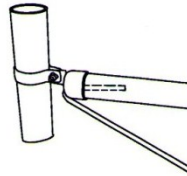

Truss Rod Detail
Upper Corner

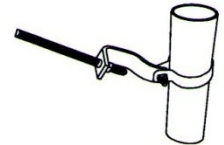

Truss Rod Detail
Lower Corner

Chainlink Fence Detail
4' - 7' High Chain Link Fence
Gate Details assembled
with connections

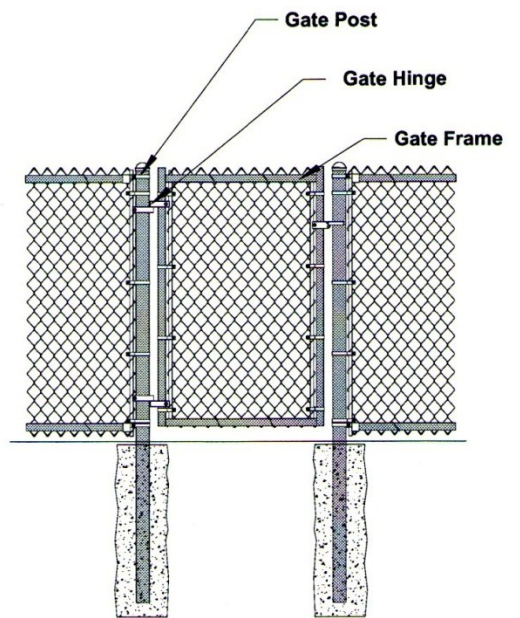
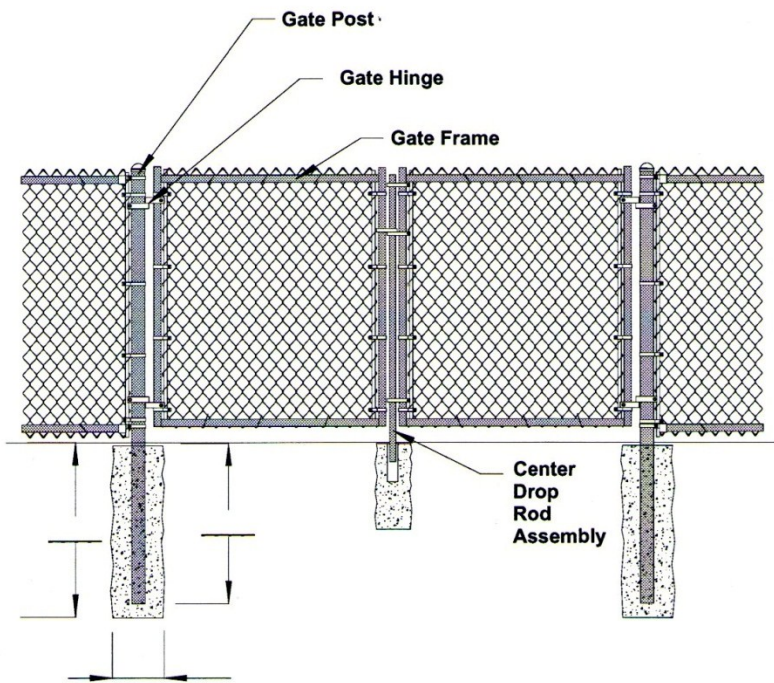

profencesupply.com

toll free 866.415.6609