



www.EasternOrnamentalFence.com | 800-339-3362

ESTATE 3/4" PICKET VERSAI (V2)



DESIGNED BY PROFESSIONALS FOR PROFESSIONALS



IN STOCK STYLES

FLAT TOP

#202 STYLE

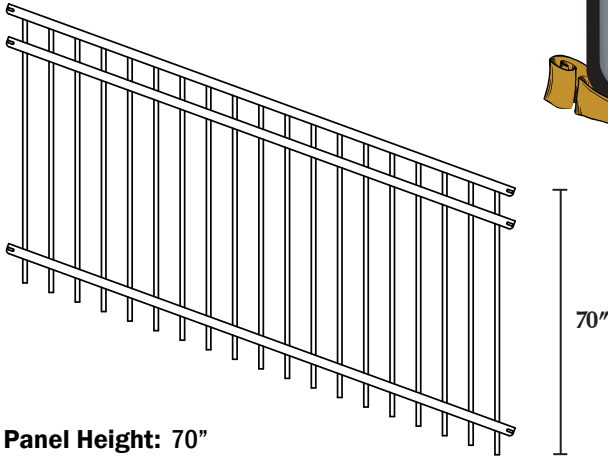

Panel Height: 70"
Panel Length: 90.5" for 95" ±1" on center

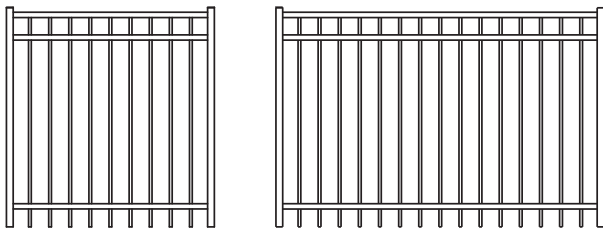

Walk Gate Opening: 4'
Standard Drive Gate Opening: 16'
Standard Commercial: 1-⁹/₁₆" x 1-³/₁₆" rail, & ³/₄" picket



PRESSED SPEAR

#101 STYLE

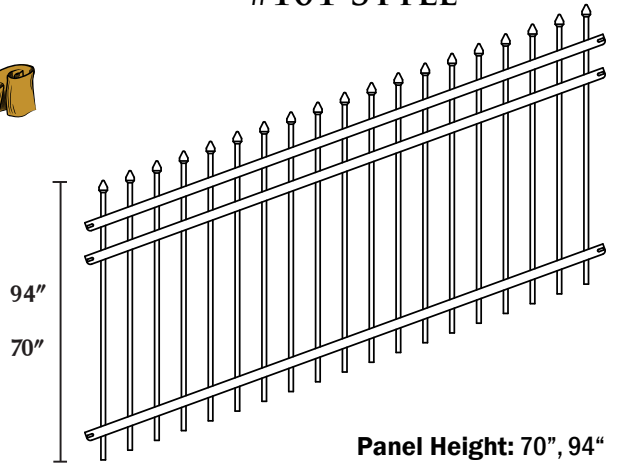

Panel Height: 70", 94"
Panel Length: 90.5" for 95" ±1" on center

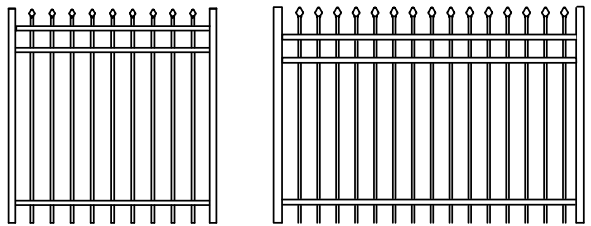

Walk Gate Opening: 4'
Standard Drive Gate Opening: 16'
Standard Commercial: 1-⁹/₁₆" x 1-³/₁₆" rail, & ³/₄" picket

SPECIAL ORDER panels & gates

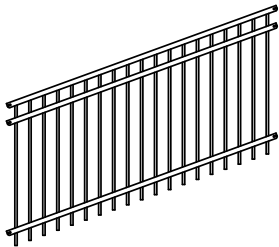

FLAT TOP
Height: 46", 58", 82", 94"

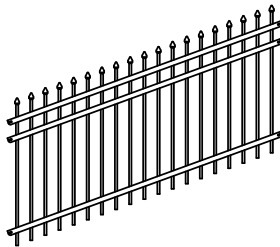

PRESSED SPEAR
Height: 46", 58", 82"

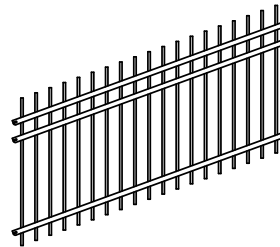

EXTENDED PICKET
Height: 46", 58", 70", 82", 94"

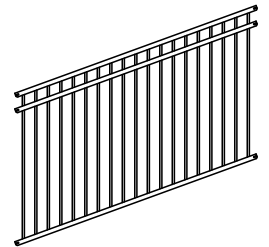

POOL PANEL
Height: 54"

BRACKETS



EXTERIOR ONE
DIRECTION
EOSBRK341

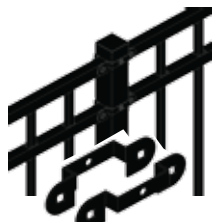

EXTERIOR TWO
DIRECTION
EOSBRK342



SWIVEL
EOSBRK345

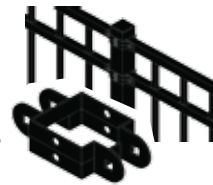

EXTERIOR THREE
DIRECTION
EOSBRK343



FEATURES & BENEFITS

- ◆ Smooth rackability with hidden pin hinge fasteners – no visible fasteners
- ◆ Adjusts up to 30" - no metal fatigue or cracking of coating
- ◆ DuPont® E-Coat plus DuPont® Architectural Grade Powder Coating
- ◆ Heavy duty commercial construction
- ◆ Brackets supplied with security fasteners
- ◆ 100% pre-galvanized steel
- ◆ 20-year limited manufacturer warranty
- ◆ AutoCAD details and 3-part specifications available with technical specification support

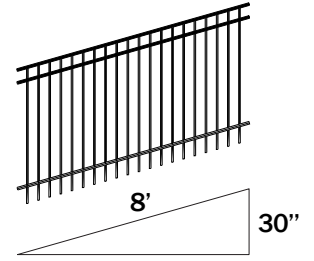

Adjusts 30" over 8' - integrity of the panel not compromised with adjustment

COATED WITH

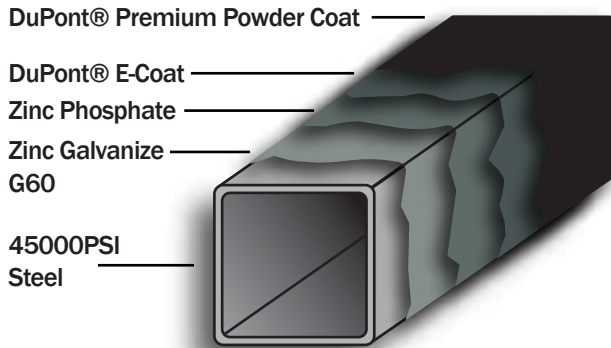

The best coating in the industry

PIN HINGE

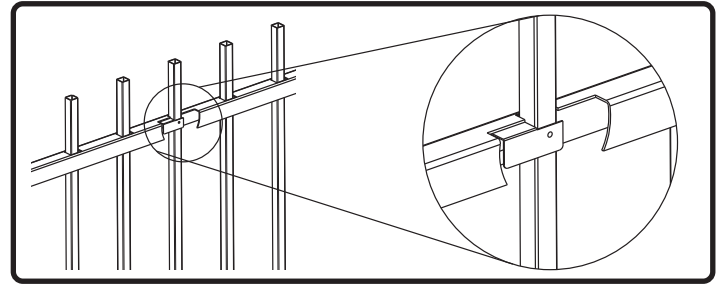

Patented adjustable system easily adapts to the most aggressive landscapes

CUSTOM FABRICATION



Eastern Ornamental is proud to offer a full range of custom fabrications to meet any size or design of panels and gates in mind. With its own custom fabrication shop, there is staff available to help design and build any panel or gate to individual specification and style. Eastern Ornamental fences are also available in a broad range of premium finishes. Carrying up to a 5-year limited manufacturer warranty, Fortress Custom Fabrications manufacture to a standard of pre-galvanized and premium powder coated steel to provide panels and gates that will withstand the elements. For assistance with developing custom panels or gates, information about custom colors and pricing, please contact us at www.easternornamentalfence.com.

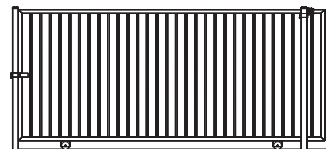

V-TRACK ROLL GATES
Standard up to 40' opg x 10' height

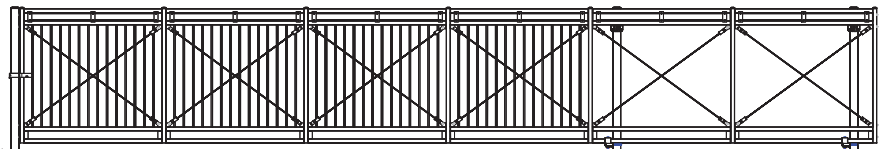

CANTILEVER GATES
Standard up to 40' opg x 10' height



SWING GATES
Standard single swing up to 18' opg x 10' height



3 PART SPECIFICATION

PART 1 GENERAL

1.01 SECTION INCLUDES:

Ornamental Rackable welded steel fence system.

1.02 RELATED SECTIONS:

Section 0503___ Metal Finishes
Section 0330___ Cast in Place Concrete.
Section 0420___ Unit Masonry.
Section 3130___ Earthwork.
Section 3231___ Paving and surface improvements.

1.04 REFERENCES:

ASTM-F593-02e2___ Stainless Steel Fasteners
ASTM A500___ Seamless Grade A metal tubing
ASTM A123___ Hot dip electroplating
ASTM E935___ Cone Penetration test (Method D)
In-fill Load Test (Method C)
Vertical Concentrated Load Test (Method B)
Horizontal Load Test (Method A)
ASTM B117-97___ Salt Spray Corrosion test
AC174-Section 4.2.2 In-Fill Load Test
Section 4.2.3 Uniform Load Test
Section 4.2.4 Concentrated Load Test
ICBO UBC-97___ Quality standards
BOCA___ National Building Codes

1.05 WARRANTY

Fortress Fence Products VERSAI products include a 20-year limited warranty, from the date of purchase, for defects in material and workmanship, including protection against cracking, peeling, blistering and corrosion (rusting). Refer to 20 Year Warranty Sheet.

PART 2 PRODUCTS

2.01 MANUFACTURER

Fortress Fence Products
1800 Jay Ell, Suite 200
Richardson, Texas 75081
Phone: 866-323-4766 Fax: 972-644-3720
Web site: www.fortressfence.com

2.02 MATERIALS

Rails are Grade A cold rolled steel formed U-Channel and Pickets are Grade A cold rolled steel formed and welded tubing, both conforming to ASTM A500 with G 60 zinc coating (0.60 oz/ft²) total inside and outside surfaces in accordance with the ASTM A123 hot dipped electroplating process. Materials also conform to ASTM E935 testing (Methods A, B, C and D) and load testing in accordance with AC174 (Sections 4.2.2, 4.2.3 and 4.2.4).

2.03 COMPONENTS

Rails: 14-gauge formed U-Channel ASTM 500 galvanized steel, 1-9/16-inch Leg X 1 3/16 inch Web.
Pickets: 16-gauge ASTM A500 galvanized welded and formed steel tubing for 4' 5' & 6' tall panels, 14-gauge ASTM A500 galvanized welded and formed steel tubing for 7' & 8' tall panels 3/4-inch square.
Posts: 16-gauge 2 1/2-inch square ASTM A500 galvanized formed and welded steel tubing with powder coated factory finish. Post caps can be nylon or pressed steel dome cap.
Fasteners: All nuts, bolts, sheet metal and wood screws are stainless steel conforming to ASTM F593-02e2 standard.

2.04 STYLE

Fortress Fence Products Versai Fence is made in four (4) styles: Flat Top, Extended Bottom (FT), Extended Top, Extended Bottom (EXT), Spear Point Top, Extended Bottom (SP), and Flat Top, Flat Bottom (PL) for Swimming Pool installations.

2.05 FABRICATION

- A. Commercial Fence panels are fabricated in standard length of 90 1/2" and standard heights of 48", 60", 72", 84" and 96" except for the PL panel which is 54" in height to meet Swimming Pool codes. All fence panels comply with all requirements indicated for materials, thickness, design and details of construction.
- B. All welded connections comply with AWS standards for recommended practice in shop welding.
- C. All components are accurately cut and drilled to receive hardware, fasteners and accessories.

2.06 FINISH

- A. Metal parts are assembled and finished individually prior to shipment.
- B. Galvanized steel fence components are cleaned with a non-petroleum solvent followed by the application of a sealing zinc phosphate coating.
- C. Immediately after sealing, a two-step finishing process consisting first of an electrostatic dipping process in a lead free high corrosion resistant epoxy resin leaving a coating of approximately 20 microns followed by a thermoset ting carboxyl polyester resin top coat with a minimum dry film thickness of 60 to 70 microns. The second coating will be applied by the electrostatic spray process.

PART 3 EXECUTION

3.01 PREPARATION

Stake layout showing locations of all gates and posts. Contact "CALL BEFORE YOU DIG" prior to beginning any excavation work.

3.02 INSTALLATION

- A. Install fences in accordance with written instructions and in accordance with authorities having jurisdiction.
- B. Concrete Set Posts: Drill hole in firm soil. Posts holes will be a minimum of 24 inches deep with a minimal diameter of 8 inches. Fence post (2 1/2") shall be spaced 94"-96" on-center to accommodate installation of brackets on 2 1/2" post.
- C. Installation is to conform to the specifications referenced in Section 1.02 of this specification.
- D. Install Fortress brackets onto fence section and posts as indicated in printed instructions for specific fence style. Attach fence sections to brackets with approved fasteners and techniques to insure that fence sections are parallel to grade within 1/4-inch in 12 feet.
- E. Gate Installation: Install in accordance with printed instructions. Do not mount gate from wall of a structure. Provide gate post on both sides of a gate. For double drive gate installation, provide concrete center drop to foundation depth and drop rod retainers at center. Lubricate to insure smooth operation and verify proper latch operation.

3.04 CLEANING

- A. Remove all cutting and drilling chips that are attached to the fencing, post, brackets or additions to prevent corrosion.
- B. Repair scratches and other installation-incurred damage. Using a spray paint of the appropriate color that includes a zinc additive, repaint and seal any scratches or holes drilled in the fencing, post, brackets, or additions to prevent rust from forming.
- C. Clean up debris and unused material, and remove from site.

WARRANTY



Fortress Fence Products manufactures fence systems using the finest in materials and coatings with FortressShield to bring you the most beautiful, strong, and durable fence system on the market.

All fence components manufactured by Fortress Fence Products and coated with FortressShield are warranted against workmanship for 20 years from the original purchase date as shown on the receipt.

For a full warranty statement or more information, please contact customer service at 1.866.323.4766 or visit our website at www.fortressfence.com.