















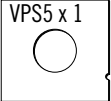

75 MPH Wind Kit™ Installation Instructions

Items Needed to Complete Installation:

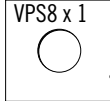
- Selected Illusions® Vinyl Fence Style
- Selected Illusions® Vinyl Post (VH55__ or VH88__)
- Adaptor Kit
- Concrete Post Mix
- Post Cap Style
- Tools
 - Philips Head Power Screw Driver
 - 1/8" Drill Bit
 - Post Hole Digger
 - Level and String Line
 - Tamping Bar
 - Illusions® Vinyl Cap Glue

Meets Dade County 75MPH Wind Load Independent Tests.
8' Maximum Width X 8' Maximum Height.

This installation guide is a recommendation for installing Illusions® Style Fences for Certification of Installation to meet 75MPH Wind Load Properties. Always check your local building codes before starting a project and for determining the acceptable installation practices of your area. Read assembly instructions completely before beginning construction. Always wear protective goggles and gloves when installing a vinyl fence.

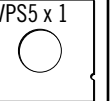
<p>V75MPH-1 Includes (per kit, per section)</p> <p>3/4" Screws x 30 </p> <p>1" Screws x 2 </p> <p>3" Screws x 4 </p> <p>Galv. U-Channel x 3 </p> <p>VPS5 x 1  Post Supporters For 5" x 5"</p> <p>(Items Not Drawn to Scale)</p>	<p>V75MPH-2 Includes (per kit, per section)</p> <p>3/4" Screws x 60 </p> <p>1" Screws x 2 </p> <p>4" Screws x 4 </p> <p>Galv. U-Channel x 4 </p> <p>VPS8 x 1  Post Supporters For 8" x 8"</p> <p>(Items Not Drawn to Scale)</p>	<p>V75MPH-3 Includes (per kit, per section)</p> <p>3" Screws x 4 </p> <p>(Items Not Drawn to Scale)</p>	<p>V75MPH-4 Includes (per kit, per section)</p> <p>3/4" Screws x 30 </p> <p>1" Screws x 2 </p> <p>3" Screws x 4 </p> <p>Galv. U-Channel 26 x 1 </p> <p>VPS5 x 1  Post Supporters For 5" x 5"</p> <p>(Items Not Drawn to Scale)</p>
--	--	--	---

Illusions® Sections - Illusions Styles of Fence Selection

Shown are the different *Illusions*® Vinyl Fence Series Styles available with the 75MPH wind kit. This covers all styles available within the series. Please consult your Illusions Vinyl Fence Catalog to see the individual style choices.

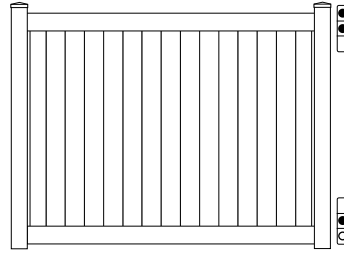

V300 Series (3' to 6' Height)
Use V75MPH-1 KIT

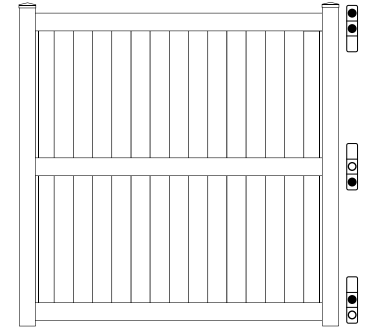

V300 Series (7' to 8' Height)
Use V75MPH-2 KIT

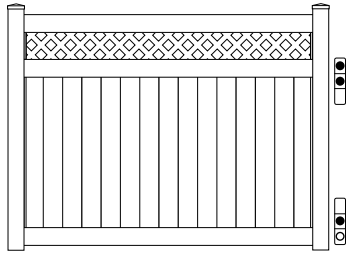

V3215 Series (3' to 6' Height)
Use V75MPH-1 KIT

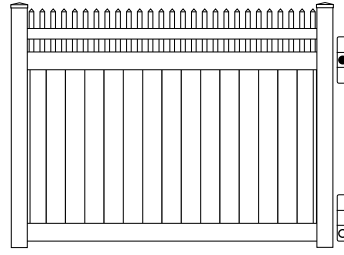

V3700 Series (3' to 6' Height)
Use V75MPH-4 KIT

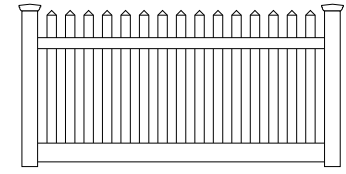

V401 Series (3' to 4' Height)
Use V75MPH-3 KIT

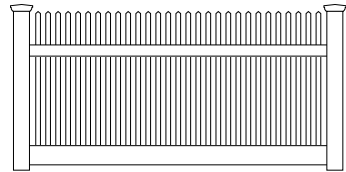

V700 Series (3' to 4' Height)
Use V75MPH-3 KIT

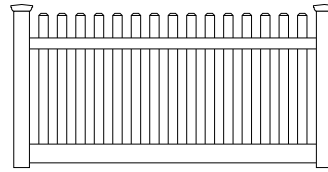

V350 Series (3' to 4' Height)
Use V75MPH-3 KIT

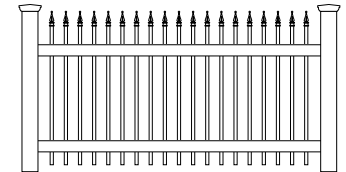

V0100 Series (3' to 4' Height)
Use V75MPH-3 KIT

**GALVANIZED U-CHANNEL
CORRECT RAILING
PLACEMENT**

- = Included with Kit
- = Included with Section

Illusions® Vinyl Posts

**5" x 5"
Heavy Duty Posts**

VH55__ Series Posts *Illusions*®
Heavy Wall 5" x 5" average wall thickness .250" for all styles up to 6ft. height fence. Select the end, line, or corner style post to be 3ft. longer than section installed 2" above top of section height.

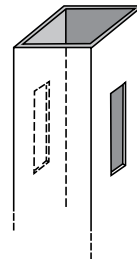

Line

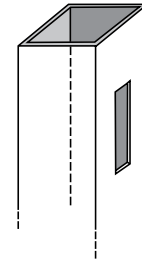

End

Important:

In order to properly certify installation with the 75 MPH Wind Kit, **HEAVY DUTY** Posts must be used.

If your Vinyl Post doesn't start with "VH" in the product code, please call back to verify that it is the correct post for your installation.

**8" x 8"
Heavy Duty Posts**

VH88__ Series Posts *Illusions*®
Heavy Wall 8" x 8" average wall thickness .250" for all styles up to 8ft. Height fence and selection. The end, line, or corner style posts to be 4ft. longer than the section installed 2" above the top section height.

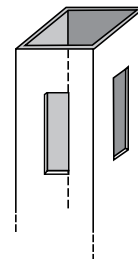

Corner

IMPORTANT NOTE:
Installer must consult local code officials for compliance to building code requirements.

STEP 1 String your line from end to end turning at corners. This will enable a straight line of fence.

IMPORTANT NOTE:
Installer must consult local code officials for compliance to building code requirements.

STEP 2 It is recommended to dig one hole at a time. The hole should be as deep as the post depending on grade. No less than 30" below grade for 5" x 5" posts and 42" for 8" x 8" posts. The diameter of the hole should be no less than 12" for 5" x 5" posts and 15" for 8" x 8" posts (See Figure 1). A premium wet or dry concrete mix is to be used depending on ground condition in the area. (Check local codes for amount of concrete to be used).

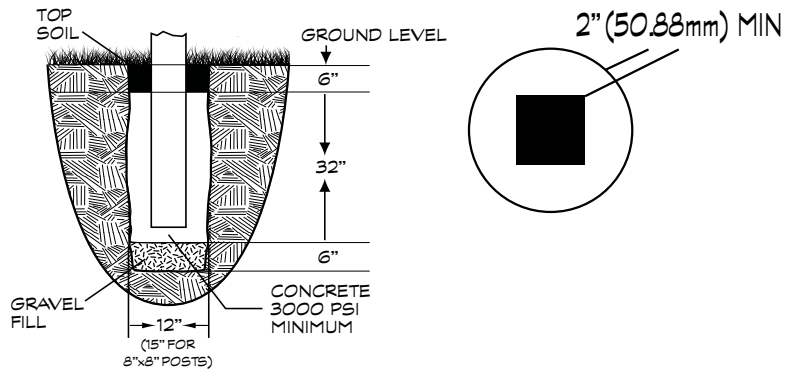

STEP 3 Snap in the pre-notched, pre-assembled section panel into the post.

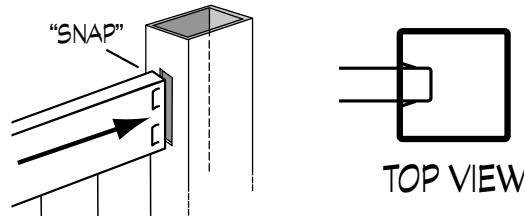

STEP 4 After post is in place, Insert metal "U"-Channels as shown in drawing into appropriate slots in rails. (See illustrations on top of page 2 for proper placement). REPEAT PROCESS WITH EACH SECTION

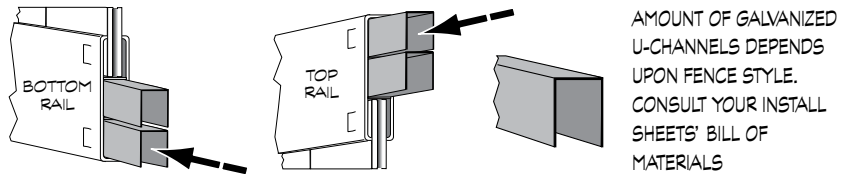

STEP 5 Level sections to desired grade.

STEP 6 Insert the post supporter "donut" (VPS5, VPS8) into the top of the posts as per diagram.

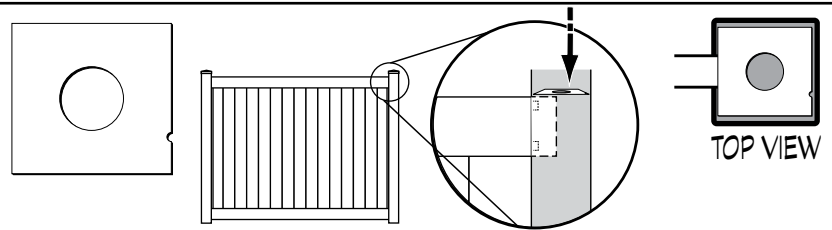

STEP 7 Insert all screws in the appropriate locations as per diagrams.

NOTE: Diagrams shown are using the V300-6 style fence. See appropriate accompanying Installation Sheets for individual fence styles.

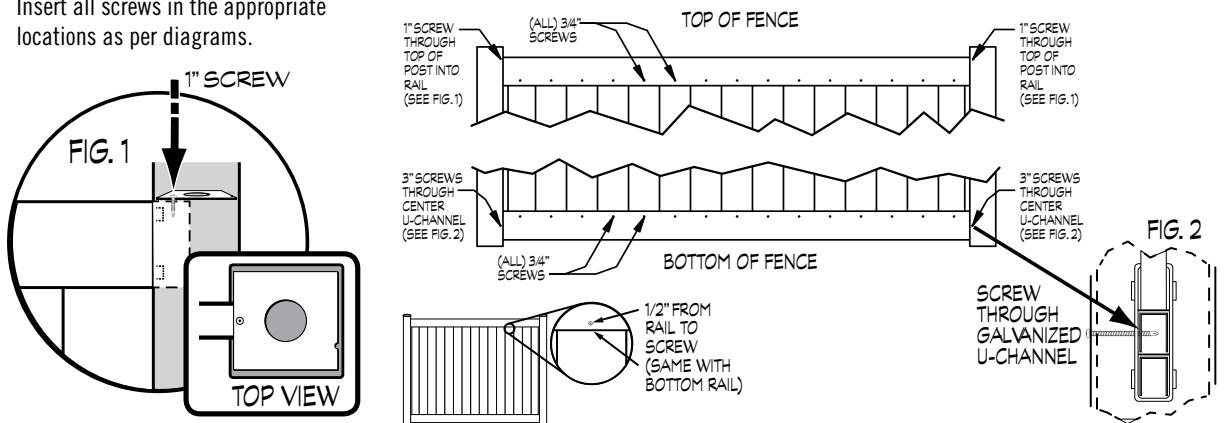

STEP 8 Lastly, use a small amount of Illusions Glue on every selected style post cap and place on top of post.



Illusions® Material Specifications

NOA# 09-0826.07

Cell Classification - ASTM D4216 1-32333-3

Scope

ASTM F964-09 is considered the “end all, beat all” testing specification for Vinyl fence. The purpose of this specification is to establish a recognized standard of quality for exterior Vinyl profiles for use in assembling agricultural, commercial, and residential fencing and railing. This specification covers **Illusions® Vinyl Fence** sections and the EverStrong® Profiles used to fabricate them.

Materials

Illusions® Vinyl Fence Products are manufactured using Rigid Poly Vinyl Chloride (PVC) compounds for exterior-profile extrusions that meet the requirements of ASTM Specification D4216.

Manufacture

Illusions® Vinyl Fence Products are manufactured to meet cell Class 1-32333-3 as defined in Specification D4216. Illusions® compounds have higher cell classification because one or more properties are superior to those used in standard acceptable compounds.

Color/Consistency Testing – The PVC compound in extruded section shall maintain uniform color and be free of any visual surface or structural changes, such as peeling, chipping, cracking, flaking, or pitting after weathering at intervals of six months and one year for white and for six months, one year, and two years for all other colors in hot, dry climate such as Phoenix, AZ;

a hot humid climate, such as Miami, FL; and a temperate northern climate, when tested in accordance with ASTM Performance Weathering Requirements (TABLE 1).

Weathering Testing – The PVC compound shall have a minimum impact resistance of 0.6 in.-lb/mil (2670 J/m) after weathering six months and one year in a hot, dry climate such as Phoenix, AZ; a hot, humid climate, such as Miami, FL; and a temperate northern climate, when tested in accordance with ASTM Performance Weathering Requirements. The PVC compound shall have successfully met the weathering requirements prescribed for six months at each climatic testing site prior to use in production of exterior-profile extrusions, when tested in accordance with ASTM Performance Weathering Requirements (TABLE 1).
ASTM Specifications Met

D256 – To determine Izod impact properties

D618 – Practice for Conditioning Plastics for Testing

D635 – Test Method for Rate of Burning and/or Extent and Time of Burning of Plastics in a Horizontal Position

D638 – To determine tensile properties

D648 – To determine heat distortion temperature

D696 – Test Method for Coefficient of Linear Thermal Expansion of Plastics Between 030°C and 30°C with a Vitreous Silica Dilatometer

D790 – To determine flexural properties

D792 – To determine specific gravity

D883 – Terminology Relating to Plastics

D1435 – Practice for Outdoor Weathering of Plastics

D1600 Terminology for Abbreviated Terms Relating to Plastics

D1784 – Specification for Rigid Poly (Vinyl Chloride) (PVC) Compounds and Chlorinated Poly (Vinyl Chloride) (CPVC) Compounds

D1898 – Practice for Sampling of Plastics

D2240 – To determine Shore hardness values

D2244 – Practice for Calculation of Color Tolerances and Color Differences from Instrumentally Measured Color Coordinates

D2565 – Practice for Xenon-Arc Exposure of Plastics Intended for Outdoor Applications

D4216 – Material Class Number1-32333-3.

To establish Cell Classification of PVC material. Illusions compounds have higher cell classification because one or more properties are superior to those used in standard acceptable compounds

D4226 – Test Methods for Impact Resistance of Rigid Poly-(Vinyl Chloride) (PVC) Building Products

D4726 – Specification for Rigid Poly(Vinyl Chloride) (PVC) Exterior-Profile Extrusions Used for Assembled Windows and Doors

E-84-04 – Used to determine the flame spread value of PVC material; Illusions® burn rate is significantly lower than allowed value

Quality Assurance

Illusions® Vinyl Fence Products are run through a series of dimensional and color tests that are performed at least every two hours. Testing includes; flattening, extrusion quality, impact resistance, warp, color comparison with standard color samples, capstock thickness, and bond testing. All will be done at the startup of a production and once per shift thereafter with a minimum of two tests per 24 hours of production.

Illusions® Vinyl Fences have been independently tested and certified to withstand winds up to 75 miles per hour. This includes our complete line of Privacy (Series V300, V3215, and V3700) up to 8 foot height. Spaced Picket Styles (Series V400, V352, V700) up to 4 foot height. We will certify Illusions® Vinyl Fences when properly installed per 75 MPH Wind Kit™ Installation Instructions using the “75 MPH WIND ILLUSIONS® VINYL FENCE CERTIFIED ADAPTOR KIT” for the corresponding style and height. Must use (VH55_ _ _) 5” x 5” Heavy Duty Posts up to 6’ height and (V88_ _ _) 8” x 8” Posts for 7’ to 8’ height. Return form within 30 days of completion stating; Owner, Location, Style, Copy of Contract, Installation Completion Date and Copy of Invoice. Certification will be sent. THAT’S IT!



75 MPH Wind Kit™ Kit Installation Instructions

1-800-339-3362 • www.IllusionsFence.com